

ASYLUM RESEARCH

Atomic Force Microscopes

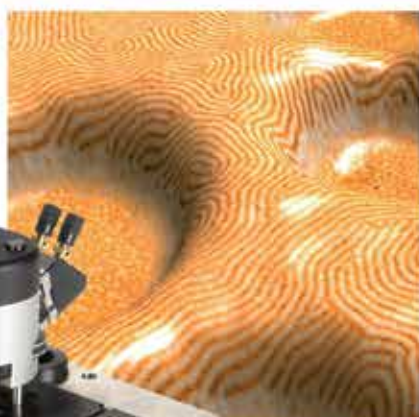

MFP-3D™
STAND ALONE

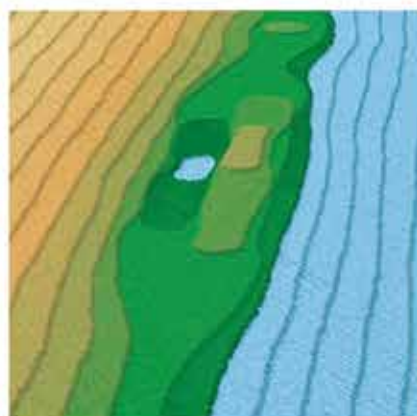
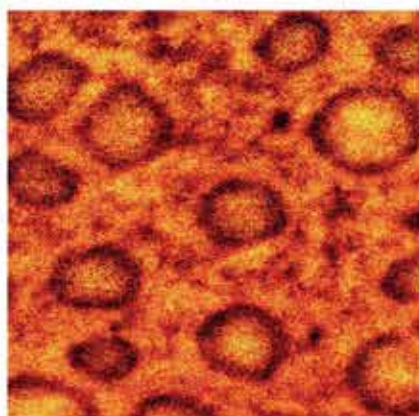
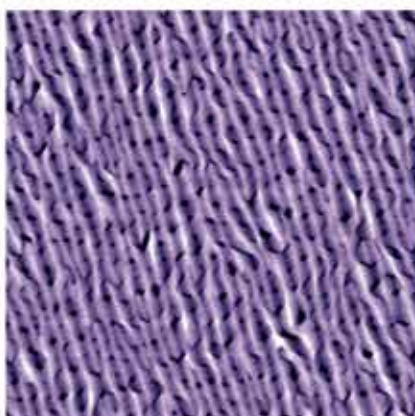
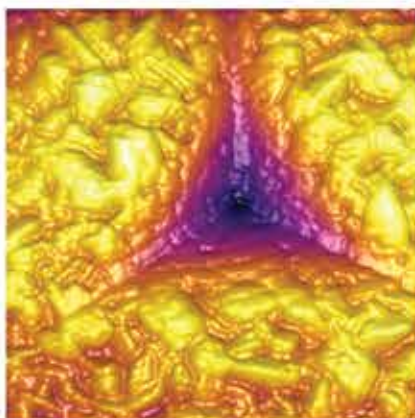

Technical Innovations

- 1 Sensored, closed loop positioning for high resolution imaging, accuracy, and reproducibility.
- 2 Pioneering all-digital controller for open software adaptability, power and flexibility.
- 3 Built-in advanced features such as real-time 3D rendering, nanolithography/nanomanipulation, and Dual AC™ Mode for dual resonance and harmonic imaging.
- 4 Designed for flexibility and expandability, with a wide range of available system, environmental and application options to enhance capabilities, including nanoindentation and Piezoresponse Force Microscopy (PFM). Please refer to the MFP-3D Options data sheet for details.

Materials Science

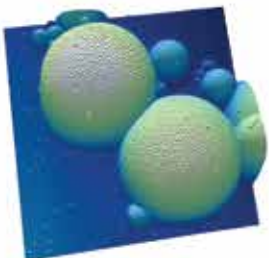

Aggregate of colloidosomes formed from the flash-curing of methacrylate emulsion droplets that are stabilized with 400nm PMMA latex spheres, 50µm scan.

Devices

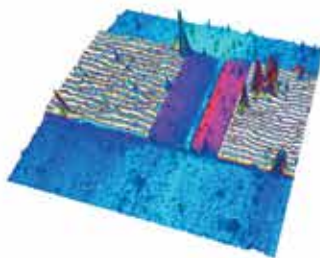

omega Zip 1GB drive write head. The MFM phase signal was overlaid on top of the topography, 20µm scan.

Life Science

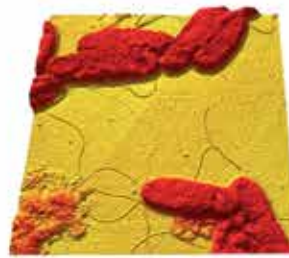

Shewanella oneidensis strain MR-1 bacteria showing conductive bacterial nanowires, 5µm scan. Sample courtesy M. El-Naggar, USC and Y. Gorby, J. Craig Venter Institute.

Advanced Applications



Nanoindentation on silicon, 1µm scan.

Designed by Scientists Who Understand the Demands of Your Research.



Roger Proksch
Jason Cleveland
Co-founders

Asylum Research was founded by scientists with the simple goal of creating the world's best research instrumentation for other scientists. We offer the most technically advanced Atomic Force Microscopes for applications such as materials science, life science, polymers, nanolithography, electrical/magnetic measurements, and nanoindenting. Asylum Research sets the bar for AFM performance.

Personalized, Exceptional Support

Once you begin your research, our staff scientists are here to help you get the most out of your MFP-3D AFM. We extend this personalized support by being virtually in your lab with "OnSight" – a remote support system that lets us view, diagnose and control your system over the Internet. Our easy, secure, web-based system enables shared screen, mouse and keyboard control of your AFM, making it ideal for training and troubleshooting.

Asylum AFMs Have the Lowest Cost of Ownership

A full one-year warranty is included with the MFP-3D-SA. Because of our robust, reliable systems, you can be sure that the cost of ownership will remain low even beyond the warranty period.



MFP-3D Head

Low noise, eliminates interference

Sensed optical lever with diffraction limited optics and a low coherence light source virtually eliminates interference artifacts. The NPS™ sensed Z axis provides precise measurements of the cantilever position for accurate force and topography measurements.

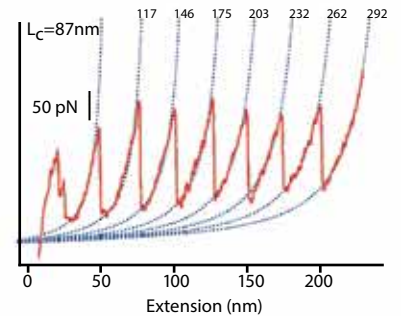
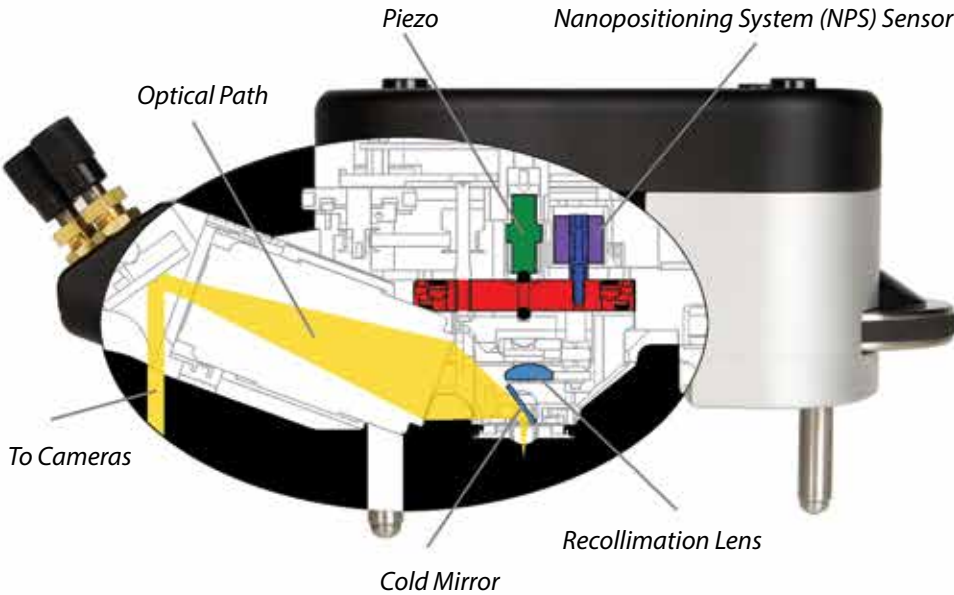
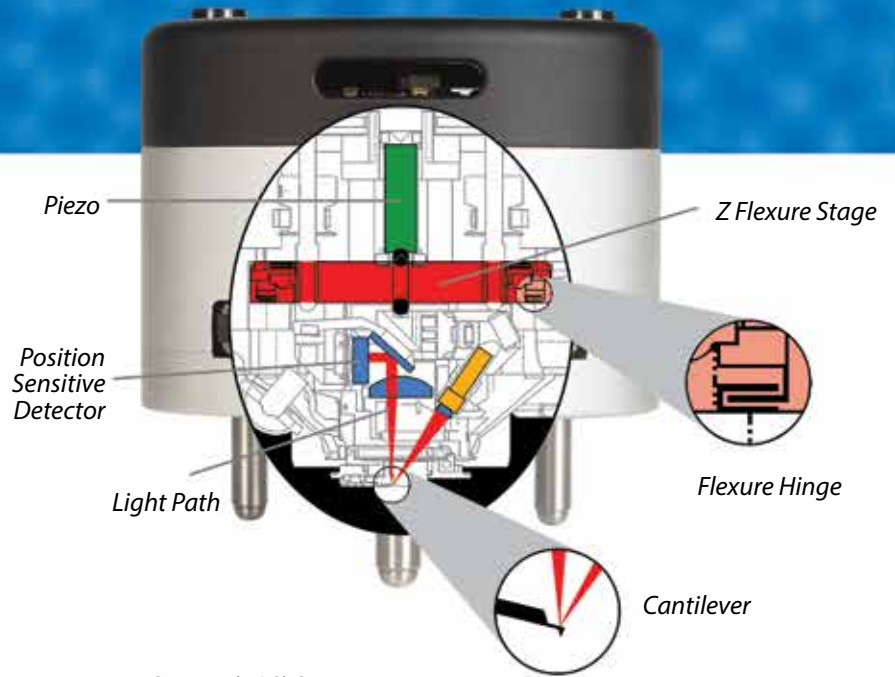

Mechanical Unfolding of Protein

MFP-3D XY Scanner

Precision and accuracy unlike any tube scanner

The MFP-3D uses a flexured scanner and patented NPS sensors which measure the exact position of each axis (X-Y). They correct for hysteresis and creep, providing flat scans and the ability to accurately zoom and offset with one mouse click.



NPS Allows Precise Zooms

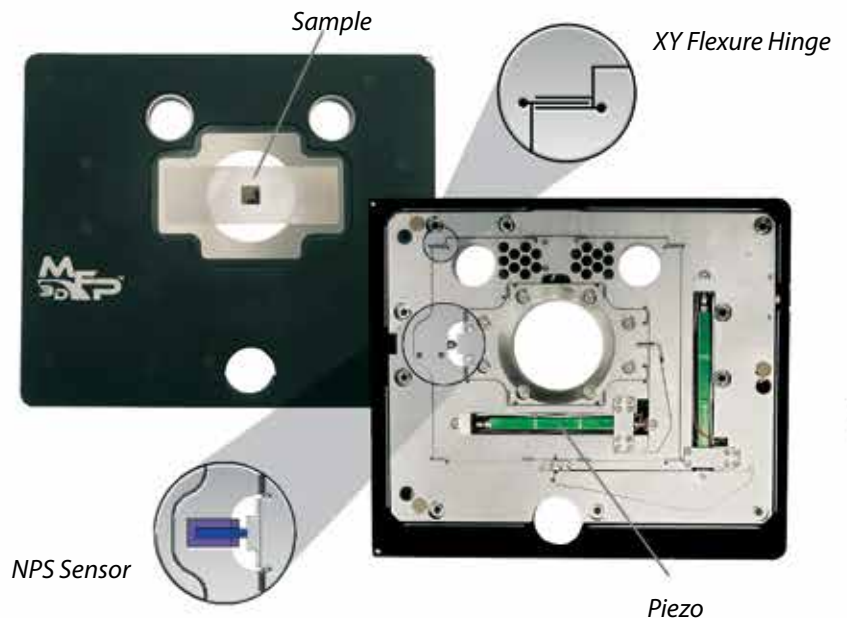

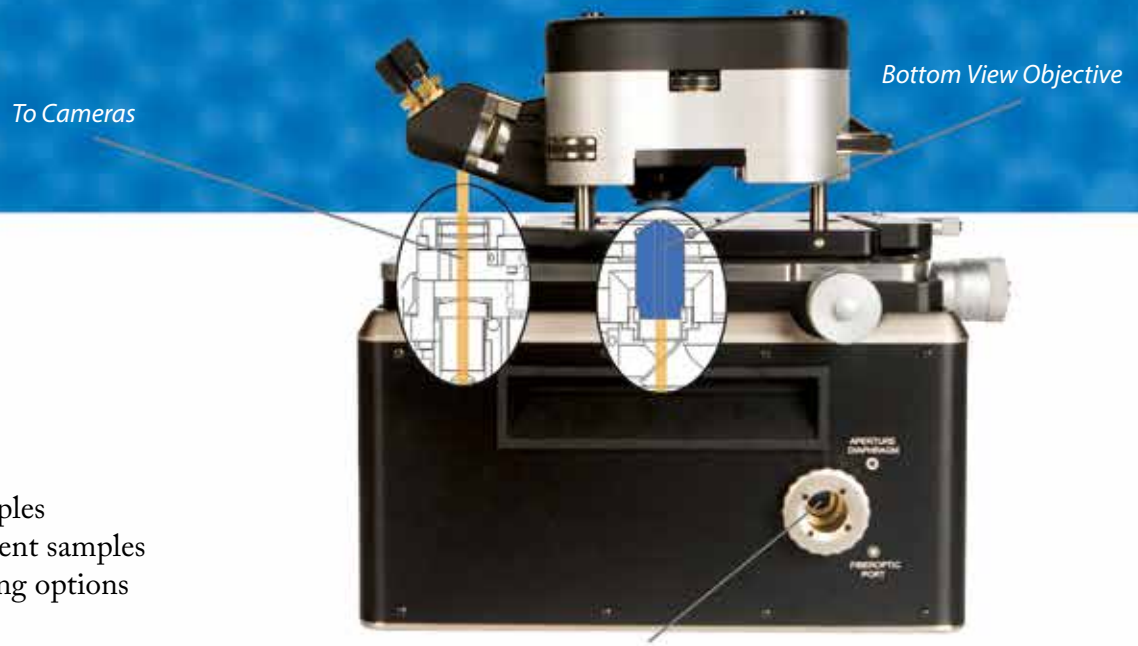

MFP-3D Base

Three configurations for illuminating and viewing your sample

- Top view for opaque samples
- Bottom view for transparent samples
- Dual view for both viewing options

Fiber Port for Köhler Illumination

All-Digital Controller and Software Flexibility

All-digital configuration allows virtually the entire system operation to be controlled through the MFP software interface (IGOR Pro) for easy addition of new microscope capabilities.

What Kind of User Are You?

Built-in Features

New	<ul style="list-style-type: none"> • ModeMaster™ - A library of standard and user-defined operation modes such as AC, Contact, Phase, EFM, LFM, PFM, Force Mode, Nanolithography • SmartStart™ - Auto configures any peripheral that interfaces with the controller for plug and play operation • 25+ megapixel resolution
Experienced	<ul style="list-style-type: none"> • MicroAngelo™ - Nanolithography and manipulation • ARgyle™ - Real3D™ rendering both on and offline • Channel Overlay – Overlay data such as EFM or phase channel on topography
Power	<ul style="list-style-type: none"> • IGOR Command and macro language at your disposal • Edit and create your own automated MacroBuilder™ routines • Software control of signal routing through crosspoint switch



All-Digital ARC2™ Controller

- 100% digital for low noise, fast operation, and flexibility
- Field Programmable Gate Array (FPGA) and Digital Signal Processor (DSP)
- Fast analog-to-digital/digital-to-analog conversions



ARgyle Channel Overlay, Second Mode (Dual AC) Amplitude Image of ZnO, 1µm Scan.

Specifications

Operating Modes

Contact Mode: Imaging using feedback on deflection. Height, deflection, and lateral force signals available.

AC and Dual AC™: Q-controlled imaging using feedback on amplitude. Signals include height, amplitude/phase, I/Q, deflection; both air and fluid.

Force Mode: Force curve acquisition in contact or AC mode. All signals available.

Lateral Force: Frictional force imaging.

MicroAngelo: Built-in nanolithography/nanomaniipulation.

EFM, Surface Potential, Conductive AFM (CAFM) with ORCA™ (optional); Magnetic Force Microscopy (MFM), Variable Field MFM (optional); Piezoresponse Force Microscopy, Vector PFM, Switching Spectroscopy PFM (high voltage optional); Scanning Kelvin Probe Microscopy (SKPM); Nanoindentation (optional); Dual AC Resonance Tracking (DART); Thermal Analysis (optional)

Data Acquisition

Data size is limited only by the memory on the PC (i.e., 10 million point force curves and >5k x 5k point images are possible). It is possible to capture data at 5MHz for up to two million points continuously.

Scan Axes

X&Y: 90µm travel in closed loop. Closed loop position control with sensor noise <0.5nm average deviation (Adev) in a 0.1Hz-1kHz bandwidth (BW) and sensor nonlinearity <0.5% (max deviation/full travel) at full scan.

Z: >15µm sensed travel. Sensor noise <0.25nm Adev in a 0.1Hz-1kHz BW and sensor non-linearity less than 0.05% (max deviation/full travel) at full scan.

Z height: noise <0.06nm Adev, 0.1Hz-1kHz BW.

Optical Lever

Noise <0.02nm Adev in a 0.1Hz to 1kHz BW.

Controller Electronics

ADCs: One 16-bit input operating at 5MHz with seven gains and a 16-bit offset. Used primarily for cantilever deflection, but also user accessible; Five 16-bit inputs operating at 100kHz. Typically three are used for the reading of the X, Y, and Z sensors and two are available for user inputs.

Frequency Synthesizer: Outputs from two Direct Digital Synthesizers (DDS) are summed and available on a 16-bit, 10MHz DAC.

Frequency: DC to 2.0MHz in 2mHz increments.

Amplitude: 0 to 20V(p-p) in 0.6mV increments. Amplitude, phase, and frequency of the oscillator can be controlled from software at 100kHz update rates.

DACs: Six high resolution, ultra low-noise, fast 24-bit channels updated at 100kHz: two for XY scanning (14kHz bandwidth); one for Z feedback (117kHz bandwidth); and three general purpose (56kHz bandwidth).

Digital Lock-ins: The 5MHz ADC is the input to two fully digital lock-ins that provide quadrature outputs. Both R/θ (amplitude/phase) and I/Q (Rcosθ/ Rsinθ) are available in output bandwidths up to 9kHz.

DSP: Floating point processor running at 80MHz.

Digital Q-control: for cantilevers from 2kHz to 2MHz; typically enhances or suppresses Q by 5X.

Computer-to-Controller Communication: Universal Serial Bus (USB).

X, Y, & Z High Voltage Outputs: -10 to +150V.

Computer: High-performance dual-monitor Windows™ computer (inquire for latest specifications and custom configurations).

Light Source

Superluminescent diode (SLD) is classified as Class 1M. Viewing with an optical instrument within a distance of 100mm may pose an eye hazard.

Stage

Micrometer driven stage for mechanical alignment of the cantilever tip and sample.

MFP Head

Standard Head: Flexure-mounted optical lever system with low-coherence SLD, liquid-compatible and AC-capable cantilever holder, dichroic mirror and window for optical access to cantilever, 80-pitch engage screws, and Invar shell.

Extended Head (optional): 40µm Z scan range.

Top View Head (optional): Adds 10x, 0.28 NA long-working distance objective with focus and beam steering adjustments, allows high resolution optical imaging of tip and sample.

Narrowband Source (optional): Eliminates interference with sensitive optical experiments.

High Bandwidth Photodiode (optional): Increases photodiode bandwidth for deflection and lateral signals to 7MHz.

Base Models

Stand Alone (SA): Three models are available.

All feature bright field microscopy with Köhler illumination, adjustable aperture and field diaphragm, remote 150W light source coupled via fiber bundle, dual 1/4" CCD's with 720µm and 240µm fields of view; integrated scanning and interconnect board, and rigid low-vibration construction.

• **Top View:** Uses infinity-corrected Mitutoyo objective in Top View head for imaging of opaque samples at 3µm resolution.

• **Bottom View:** For transparent samples only. Default configuration is 10x/0.25 NA infinity-corrected objective. Others available upon request.

• **Dual View:** Combines features of Top and Bottom View, with switchable shutters. Allows for transmitted light in either direction.

Sample Holders

For samples up to 3.4"x1.5", including glass slides and coverslips. Specialized sample holders including flow-through and heating available (see Options Data Sheet).

Software

Open user interface based on IGOR Pro incorporates professional-quality analysis and graphing capabilities. AFM analysis includes section, histogram, roughness, particle analysis, and masking.

Features include but not limited to:

- Nonlinear curve fitting to arbitrary user-defined functions.
- Extensive image analysis including 2D FFT's, wavelet transformations, convolutions, line profiles, particle analysis, edge detection (eight methods, including Sobel), and thresholding (five methods, including fuzzy entropy).
- Automatic spectral fitting and calibration of cantilever spring constants using thermal noise and Sader method.
- Easy generation of scientific publication quality graphs and page layouts.

MFP-3D-SA is a Class 1M Laser Product

ARgyle: OpenGL® 3D rendering technology for advanced image display.

- Generate, display, and visualize 3D images in real-time while you scan as well as off-line processing.
- Overlay alternate channel data with primary to view feature correlation.
- Independent scaling of axes for true 1:1 aspect ratio.
- Mouse-driven rotating, panning, scaling, and specular lighting control of images.
- Export 3D images to clipboard, JPEG, TIFF, BMP, PNG, STL, VRML 2.0.
- Stereo anaglyph creation from 3D images.

Vibration Isolation

Vibration isolation is recommended for all systems. See Options Data Sheet.

Additional Options

A wide range of system, environmental, and application options are available to enhance the capabilities of the MFP-3D-SA. See MFP-3D Options Data Sheets for additional information.

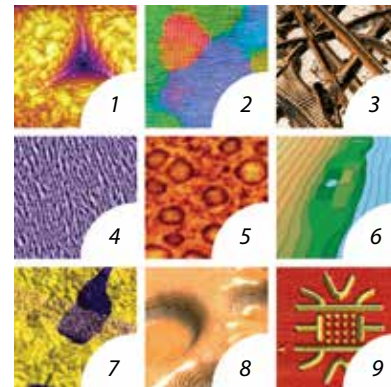

Cover Images

1. Nanoindentation of indium tin oxide, 800nm scan.
2. Block copolymer self-organized into a close-packed lattice of spherical microdomains. Lattice orientation (color) overlaid on height data (light/dark) illustrates grain boundaries and defects, 16µm scan. Sample courtesy of M. Trawick, Univ. of Richmond.
3. Type I collagen imaged using Dual AC mode. Fundamental resonance phase data overlaid on AFM topography, 4µm scan.
4. Strain-induced corkscrew pattern on MBE grown AlGaAs, 12µm scan. Sample courtesy of T. Daniels-Race, LSU.
5. EFM photoinduced charging rate map generated by plotting the inverse exponential time constant for photoinduced charging at each point from the AFM image (not pictured). Dark rings indicate regions of slower charging. Image courtesy of D. Coffey and D. Ginger, Univ. of Washington.
6. Sapphire crystal following annealing at 1400°C leaving a clean surface with atomic steps (~3Å tall) and occasional defects, 12µm scan. Image courtesy of S. MacLaren, UIUC.
7. Lead titanate film with PFM phase data overlaid on AFM topography, 5µm scan. Image courtesy of A. Gruverman and D. Wu, UNL. Sample courtesy H. Funakubo.
8. SEBS spuncoat onto a silicon wafer. Phase data overlaid on AFM topography, 2µm scan. Sample courtesy of R. Segalman and A. Hexemer, Kramer Group, UCSB.
9. Quantum dot structure created on a GaAs wafer using oxidation lithography, 2.5µm scan. Courtesy of D. Graf and R. Shleser, Ensslin Group, ETH Zurich.

ARC2, ARgyle, Dual AC, MFP-3D, MicroAngelo, ModeMaster, MacroBuilder, NPS, ORCA, Real3D, and SmartStart are trademarks of Asylum Research. Other trademarks are those of their respective owners.

Represented by: